

SKY RIPPER SYSTEMS

29mm hybrid rocket motor kit.



Thank you for buying a Sky Ripper Systems hybrid rocket motor. This motor hardware has been designed to give you years of flying enjoyment with the proper maintenance and care. Please thoroughly read these instructions to familiarize yourself with the use and care of your new rocket motor. If you are new to hybrid propulsion, spend some time to get to know the names of the parts, and their location in the motor system.

	<i>Item</i>		<i>Item</i>
1	Snap Ring	*9	APCP Preheater Grain
*2	-116 O-Ring (3)	*10	ABS Fuel Grain
3	Vented Bulkhead	*11	-114 O-Ring
4	Motor Casing	12	Reusable Nozzle
5	Compression Nut	13	Nozzle Insulator
*6	Compression Sleeve	*14	Nozzle Washer
7	U/C Injector Body	*15	1/8" Fill Tube
*8	Igniter	*	<i>Included in the Sky Ripper Systems 29mm Reload kit</i>

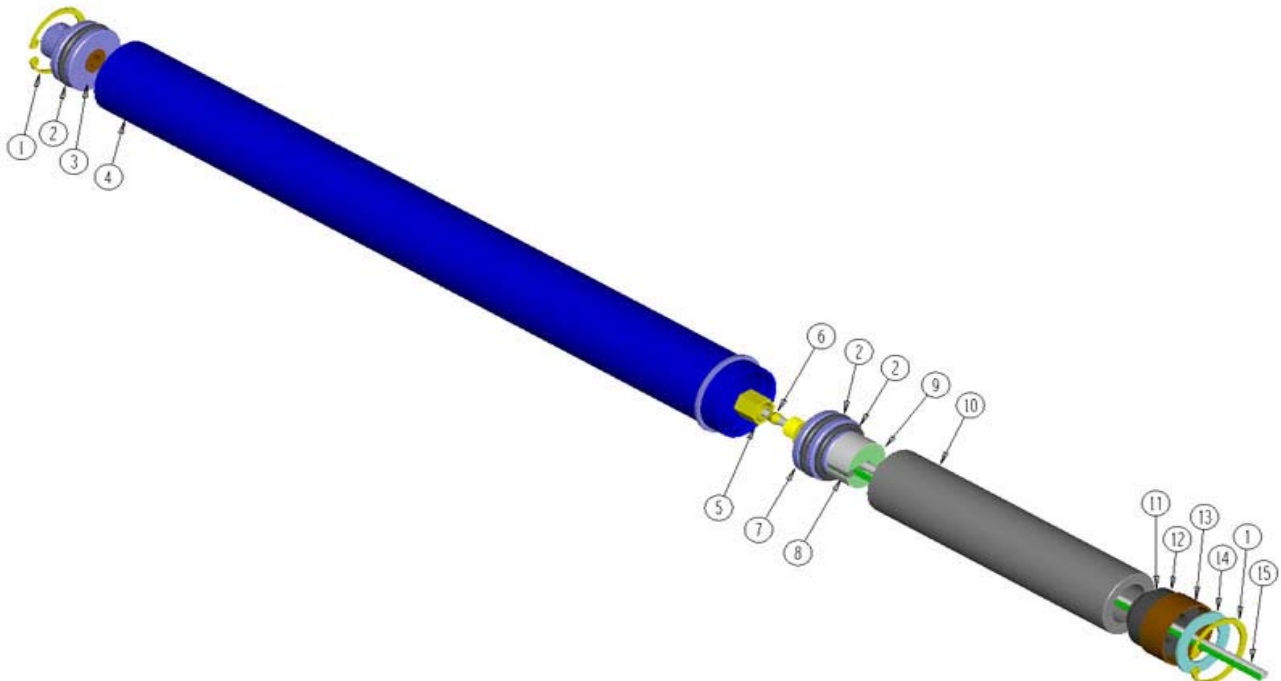

WARNINGS:

This hardware is certified by the Tripoli Rocketry Association as delivered to the end user by Sky Ripper Systems, and as assembled according to this document. Making changes to any part of the hardware or reload kit will render the motor uncertified, and not eligible for Tripoli or NAR sanctioned commercial launches.

This hybrid rocket motor must be remotely filled with nitrous oxide from a distance of no less than 100ft. No oxidizer other than nitrous oxide is to be used with this hardware.

This hybrid rocket motor hardware may only be used when following the Tripoli Rocketry Association safety code.

Never fill or fire Sky Ripper Systems hybrid rocket motors when the nitrous oxide pressure is higher than 900psi, or less than 550psi.

Always wear protective clothing on exposed flesh and safety eye wear when working with nitrous oxide or setting up hybrid ground support.

Never use petroleum based products in conjunction with your hybrid rocket motor hardware. This includes petroleum based greases used in reload assembly, and petroleum based cleaning solvents that could be used during motor cleanup. Use ONLY items known to be oxygen safe in conjunction with your hybrid motor hardware.

Never approach your hybrid rocket motor after an ignition failure until you are SURE all nitrous oxide has been purged from the flight tank.

Do not handle pyrotechnic elements of the Sky Ripper Systems reload kits around open flames, while smoking, or in any circumstance when a spark or flame may be present.

The Sky Ripper motor hardware will be HOT after firing. Please allow for a proper cooling period before handling the motor hardware after firing.

Failure to heed these warnings could result in damaged or destroyed motor hardware or personal injury.

Contact Sky Ripper Systems if you have any questions about this hardware, or are unclear about any part of motor assembly or operation.

Things you will need:

You will need some tools and supplies not included in the Sky Ripper Systems hardware or reload packages.

- A) A good pair of snap ring pliers.

We can't stress enough the need for a good pair of snap ring pliers. A cheap pair of pliers will cause you grief and could cause damage to the snap ring grooves if your pliers decided to give way at the wrong time. Invest in a good snap ring plier set, and you will save yourself frustration later.

- B) A 5/16" wrench.
C) A tube of oxygen safe lubricant.

Sky Ripper Systems uses and recommends Dupont Krytox® lubricant. Never use a grease or lubricant that is petroleum based.

- D) A 1/2" diameter dowel to use as a helper to push motor components out of the casing after firing.
E) A roll of vinyl electrical tape.
F) 1/8" OD plastic vent tube.

This tube can be purchased at many hardware stores by the foot, and is quite cheap. A two foot piece will be all you'll need for many flights.

Before you begin:

Every time you get ready to assemble your Sky Ripper Systems hybrid rocket motor you should inspect all of the o-rings to look for damaged or burned rings, and replace any o-ring that looks damaged. The o-rings that seal the fuel grain^{(2),(11)} should be replaced after every firing. Also thoroughly inspect the nozzle. Some wear may occur after each use, but by taking care not to drop or stress the nozzle it should last many firings. If the nozzle is excessively worn, cracked or broken, do not use it. Contact Sky Ripper Systems for a replacement. Also make sure that the motor case and components are clean and free from dust, sand and debris.

OK, Let's assemble the motor.

Locate the Injector body assembly⁽⁷⁾, compression nut⁽⁵⁾, compression sleeve⁽⁶⁾, fill tube⁽¹⁵⁾ -116 o-ring⁽²⁾ preheater⁽⁹⁾ and igniter⁽⁸⁾ from your Sky Ripper Systems reload kit.

Place the -116 o-ring over the lip on the aft end of the injector. It is not necessary to lubricate this o-ring. Some prep work is required on the fill tube before it is flight ready. The tube is delivered wrapped in a coil, so it will retain the memory of a lazy arc at both ends. Take one end of the tube and bend the last 4 inches of it *opposite* of its natural bend. You will need to bend the tube in a few places along the 4 inch span to get the tube straight. Holding the injector body, push the straightened end of the fill tube through it, starting at the hole in the aft end of the injector and stopping when about 1/4" of tube is exposed over the top of the brass fitting. Now place a compression sleeve over the fill tube. If you have trouble getting the sleeve over the fill tube, debur the top edge with a hobby knife. Next, take the compression nut and place it on the fitting, over the sleeve and tube, and screw it on with your fingers until it is snug. Use your 5/16" wrench to do the final tightening of the compression nut. ***Use care not to over tighten the nut.*** Holding the injector body in your hand and using the wrench to tighten should be all the force you need to compress the sleeve and create a seal.

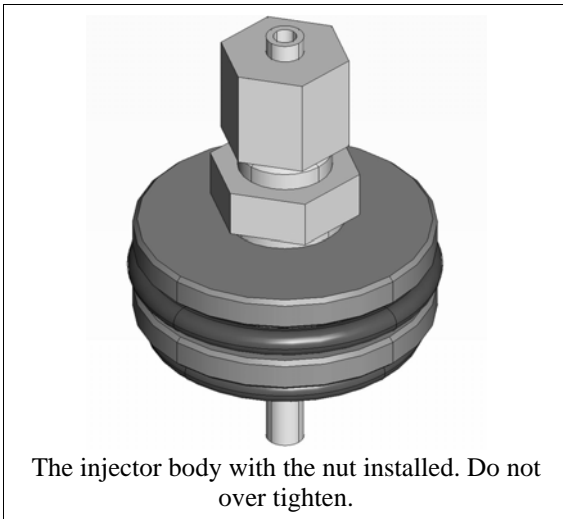
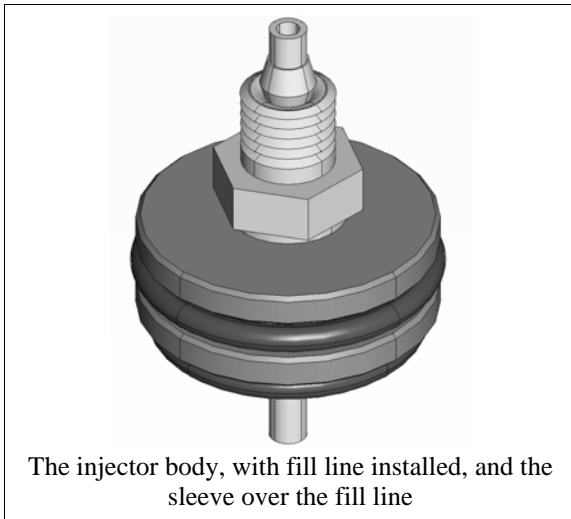

Take the igniter and bend the pyrogen end down so it is parallel with the leads as shown in the diagram. Place the igniter in the slot of the preheater grain, so that the pyrogen is toward the outside, and the wires go through the grain on the inside. Doing this is important to motor function, as the wires create some insulation to keep the fill tube from rupturing upon ignition. The igniter wire should be flush with the forward end of the preheater, and extend past the bottom by about 1/4".

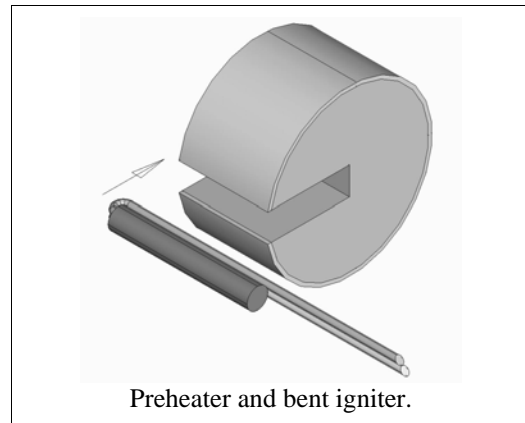

Now, locate the fuel grain⁽¹⁰⁾, and hold it so that the end with the large opening (the forward end) is facing you. Squeezing the preheater near the igniter, thread the igniter leads through the core, and press the preheater/igniter assembly into the fuel grain. It should be a tight fit, and the igniter should be held in place due to the compression of the preheater against it.

Take the injector body assembly, and push the fill tube through the slot in the preheater in the area not occupied by the igniter. Continue pushing until the fill tube extends out the opposite end of the fuel grain. Pull the remainder of the fill tube thru the center of the motor, stopping when you have seated the fuel grain against the O-ring on the aft end of the injector body. Secure the igniter to the fill tube with a piece of tape about 2" past the aft end of the fuel grain. This will ensure the igniter isn't accidentally pulled free prior to launch. See the diagram below for the final sub-assembly.

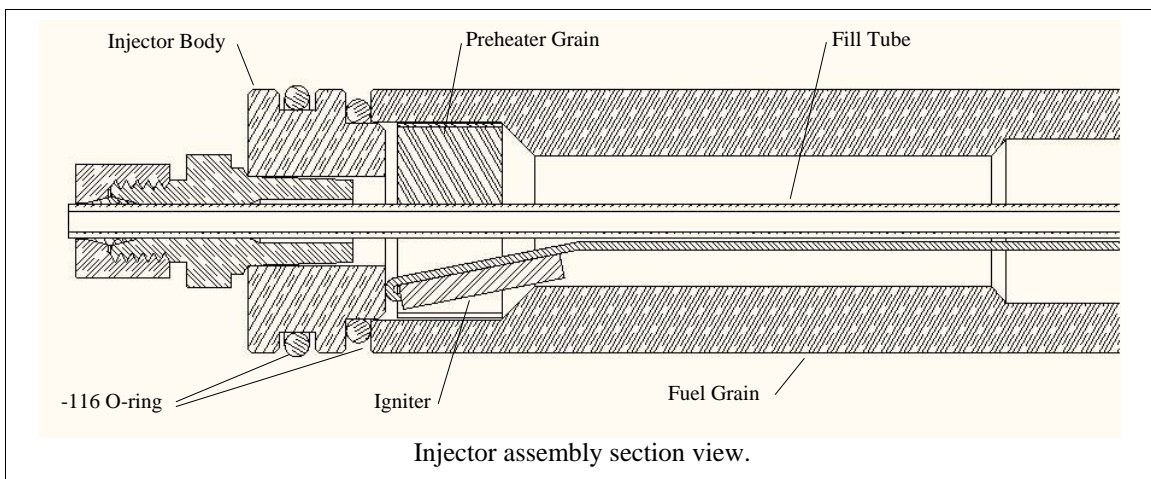

Using Krytox® or other oxygen safe lubricant, apply a liberal bead of lube to inside of the aft end of the of the motor casing⁽⁴⁾ forward of the retaining ring groove. Next, coat the injector body o-ring. Smear the lube with your fingers, around the diameter of the Injector body to make sure you have a complete coating.

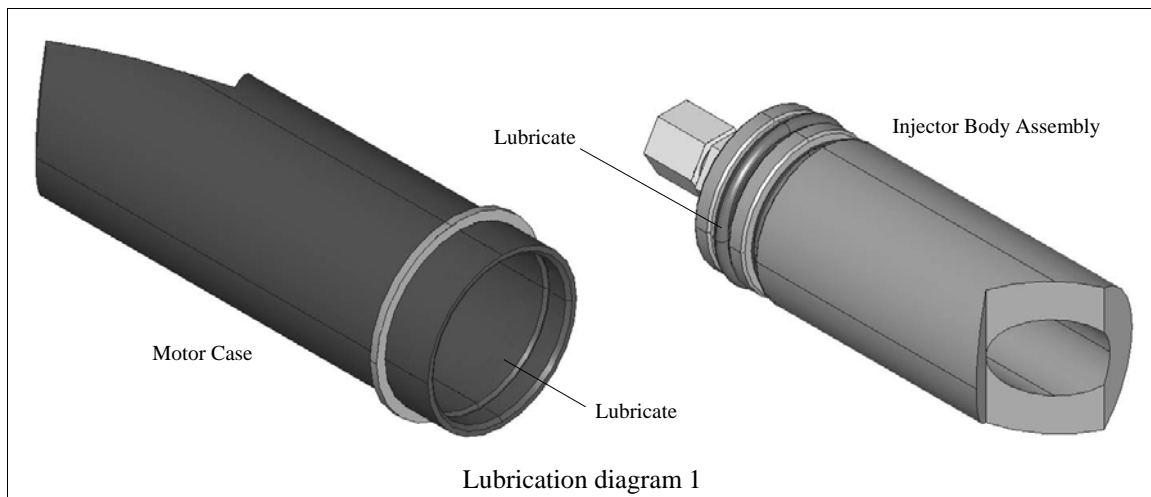

Now slide the injector body assembly into the motor casing. You will feel some resistance as the o-ring compresses entering the case, and again as you push it past the backside of the snap ring groove. Continue to push with aft end of the plastic fuel grain, until the end of the fuel grain is nearly flush with the end of the case.

Locate the graphite nozzle⁽¹²⁾, nozzle insulator⁽¹³⁾ and grain seal o-ring⁽¹¹⁾.

Place the -114 o-ring over the step on the nozzle. **Do *not* lubricate this o-ring.** The o-ring will create a seal as it melts, and lubrication will not allow the o-ring to properly melt. Next place the nozzle insulator around the nozzle, and lightly grease the outside of the insulator. Thread the completed nozzle assembly over the fill tube, stepped end first. Insert the stepped end of the nozzle into the bored end of the plastic fuel grain, and continue sliding the assembly into the case. Push the assembly forward until it is 3/16 to 1/4 of an inch past the back edge of the snap ring groove. Locate the nozzle washer⁽¹⁵⁾ and thread it over the fill line, and put it into the motor case, against the nozzle. With the nozzle washer in place, there should be between 1/16 and 1/8 of an inch of clearance between the retaining ring groove, and the nozzle washer.

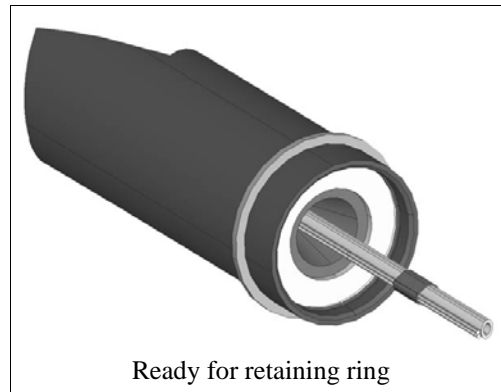

Using your snap ring pliers, install the retaining ring⁽¹⁾ into the retaining ring groove. **Make sure that the retaining ring seats completely and solidly in the groove.** After the ring is installed, tug on the fill line to seat the injector body, fuel grain, nozzle and washer against the retaining ring. The finished aft assembly should look something like the drawing below.

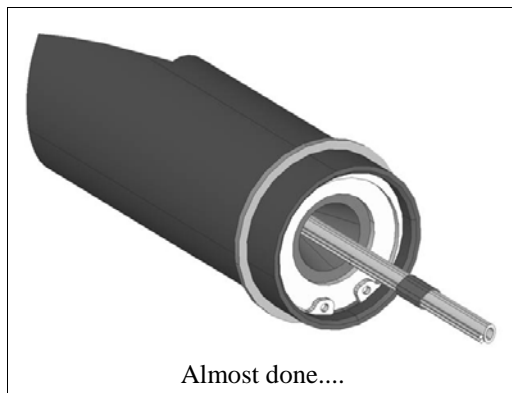

Note: *Always wear eye protection when installing and removing retaining rings.*

Locate the venting bulkhead⁽³⁾.

Lubricate the forward end of the motor case with oxygen safe lubricant inside of the retaining ring groove in much the same way the aft end of the case was done. Apply a liberal coating of lube to the venting bulkhead O-rings. Smear the lube on with your fingers, making sure to get a good even coating.

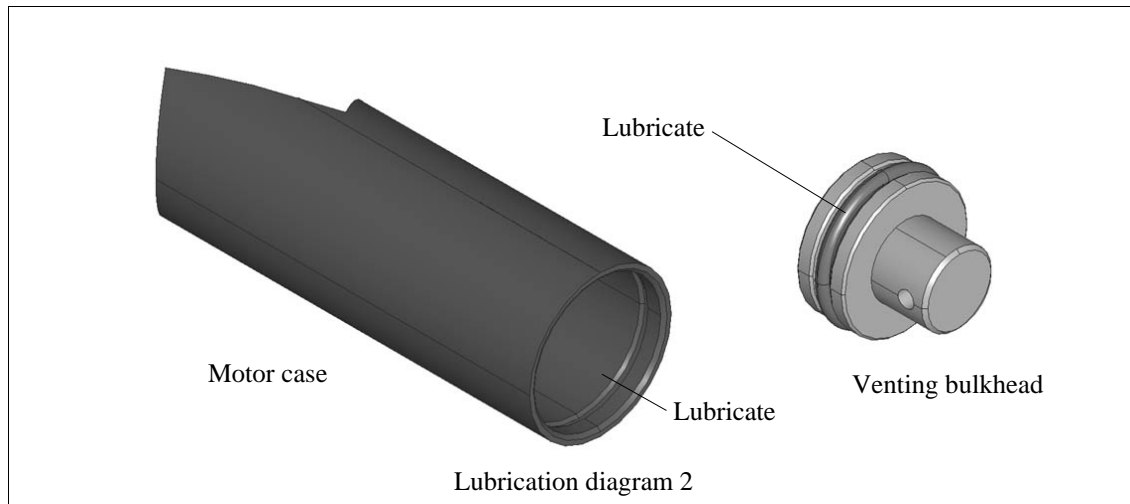

Insert the venting bulkhead into the motor case. Push the bulkhead in until the wide step is even or past the back edge of the retaining ring groove. With your snap ring pliers, install the retaining ring into the retaining ring groove, making sure that it is securely and solidly seated into the groove. Pull outward on the bulkhead, making sure it is firmly seated against the snap ring.

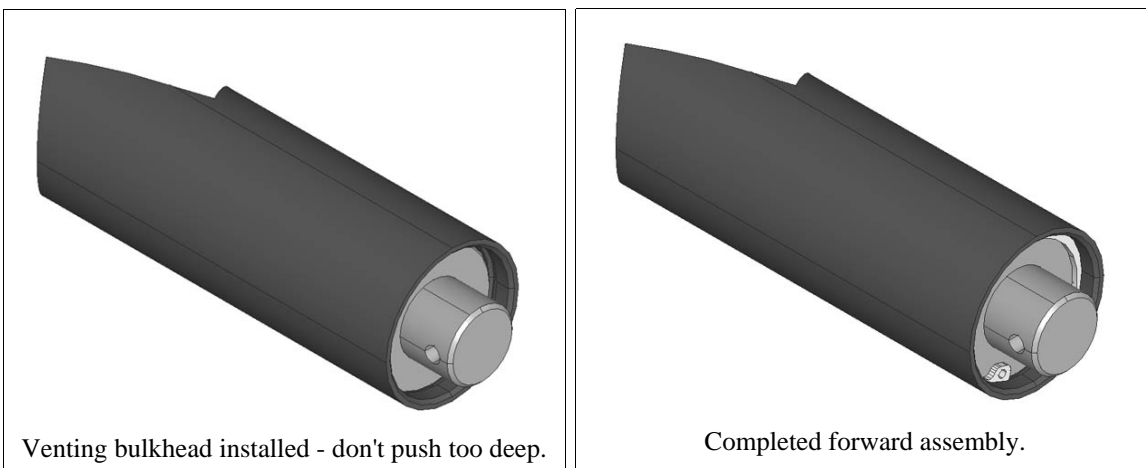

Congratulations! Your Sky Ripper Systems rocket motor is now ready for flight!

Now let's get your rocket ready to rip the sky!

In order to fly the motor in your rocket, some allowance must be made for venting the air and vaporous nitrous oxide from the motor tank during the filling phase. This is best accomplished by drilling a small hole through the airframe at a point on the rocket body that matches where the motors vent hole will be when the motor is installed. below is a chart showing the vent hole locations for the 3 29mm Sky Ripper motor configurations:

<i>Motor Hardware</i>	<i>Overall length of assembled motor</i>	<i>Distance from the aft end of motor mount tube to the center line of vent hole</i>
29/75	12-1/8"	11-5/8"
29/125	16-1/8"	15-5/8"
29/185	20-5/8"	20-1/8"

Using a 3/16" drill, make a hole in the rocket body the proper distance from the end of the motor mount tube. *Note that this number is from the end of the motor mount tube, and not from the end of the rocket body tube.* Place the vent hole on a spot 90 degrees in either direction from the launch lug / rail guide. This will position the vent in an orientation that will make it easy to see from the LCO position. Make sure not to put the vent hole in-line with the launch guides.

Put the Sky Ripper motor hardware into your rocket, and align the hole in the vented bulkhead with the vent hole you just drilled. Push a piece of 1/8" plastic vent tube through the vent hole into the rocket body, and into the hole in the vented bulkhead. It is OK to push the tube in until it bottoms out in the hole. Clip off any extra tube that is hanging outside of the rocket. If you want to secure the vent tube, a small drop of CA placed on the tube where it intersects the rocket body will keep it in place. It will easily break free with a tug post-flight.

Ground support equipment setup:

All Sky Ripper Systems 29mm hybrid rocket motors are filled remotely through a 1/8" diameter nylon fill tube. Your nitrous supply ground support equipment will need to terminate at a fitting capable of connecting to this 1/8" tube. The igniter supplied with your Sky Ripper Systems reload kit can be initiated with any 12 volt launch system. For detailed information about ground support issues and setup, see the Sky Ripper Systems web site: www.skyrippersystems.com

Launch procedure:

Set your rocket on the pad and arm the deployment device. Connect the fill hose to the ground support equipment, and open the supply tank valve. Connect the 12v ignition system to the igniter leads, check continuity (if applicable) and move off to viewing position. The LCO will announce the flight, and filling will commence. When a visible vent is observed from the vent tube, a countdown can be started. To save nitrous and preserve flight tank temperature, the countdown should be started at 3. At ignition, the igniter will fire and start the preheater grain. It is normal to have a delay of up to 3 seconds while the preheater melts through the heavy walled plastic fill tube. Once this tube is severed, your rocket will climb skyward. In the event of a misfire, the N20 should be purged from the flight tank before anyone approaches the pad. If the ground support equipment is not equipped with a dump solenoid, you must wait for the contents of the tank to boil off through the vented bulkhead. This will take several minutes. In the event a dump is needed, Sky Ripper Systems strongly suggests replacing the fill tube with new one.

Recovery and post flight cleanup:

CAUTION: *The rocket motor will be very HOT after firing. Allow adequate time between recovery and removing the motor from the rocket to ensure all motor components have cooled to safe levels.*

Extract the motor from the rocket and remove the snap ring retaining the vented bulkhead. Grab the bulkhead by the 'top hat' and pull it out of the motor. The o-rings will fall into the snap ring groove as you pull, so you will feel some resistance. It should easily pull free. Next, remove the snap ring from the aft end of the motor tube, and remove the nozzle washer. It should freely fall out of the case once the snap ring is removed. Using a wooden dowel placed into the forward end of the motor, push against the injector. As you push, place your hand at the aft end of the case to protect the nozzle as it exits. Continue to push against the injector until all of the motor pieces are extracted.

You may find that the nozzle is 'stuck' into the end of the fuel grain. This is normal, and is easily overcome. Grab the nozzle in one hand, and the fuel grain in another, and give a sharp twist. Don't try to 'bend' the nozzle out of the fuel grain – you may break it.

Dispose of the spent fuel grain and nozzle insulator in a proper manner. Clean all of the aluminum parts, washers and snap rings with warm soapy water and a rag. Wipe the nozzle down with a dry rag, removing the residue left from the O-ring seal. Clean the case by putting a clean, wet rag into the *forward* end of the case. Run the rag through the case with your dowel. Do this a few times, and then run a dry towel through in the same manner. Your hardware is clean, and ready to fire again. Do not clean your Sky Ripper Systems motor parts with any solvent. Soap and water is all that is needed. Never use a metal rod as a push out tool, only use wood or plastic.

Make sure you store your motor parts in a safe place, and take special care to store the nozzle in a manner that allows it to be protected from jarring and sharp impacts. The nozzle is the most delicate part of your motor system, and is a lot more likely to be damaged when handled or stored between firings than when being operated in the rocket motor.

Safety information:

When working with nitrous oxide, always wear protective gloves and eye wear. Avoid direct contact of nitrous oxide with skin, as it will cause frostbite.

First aid for exposure to N2O:

Eyes: Allow liquid to evaporate. Consult an Ophthalmologist.

Skin: Flush Affected areas with luke warm water.

Inhalation: Introduce fresh air and supplemental oxygen as needed.

In all cases of exposure, consult a physician.

First aid for burns:

First degree burns: place burned area in cool water, and wrap in clean, dry gauze for protection.

Second degree burns: Immerse burn in cool water. Blot dry with clean towel, and cover with sterile bandage. Consult a physician.

Third degree burns: Do not remove clothing from around burned area. Do not put water or medication on burn. Place clean, dry cloths on burnt area, and seek emergency medical attention at once.

Warranty:

All Sky Ripper Systems rocket motor hardware components and reload kit components are warranted against defects in materials and manufacturing for a period of one year from date of purchase. Sky Ripper Systems liability will be limited to replacement of motor hardware only. Nozzles are perishable items and as such, wear is normal. Replacement of nozzles that exhibit normal operational wear or damage typical of mistreatment is the responsibility of the end user. Sky Ripper Systems will replace any nozzle that is damaged as a result of defects in material or manufacturing.

Appendix:

Krytox® is a registered trademark of the Dupont corporation.

See the Sky Ripper Systems website for complete motor data and thrust curves.

www.skyrippersystems.com

For a great line of hybrid ready launch vehicles, see the new Public Missiles line of hybrid rocket kits at www.publicmissiles.com

Notes:

Disclaimer:

This motor hardware is sold to the end user for hobby rocketry use only. Use of this motor must be in accordance with these instructions and the Tripoli Rocketry Association safety code. Sky Ripper Systems will not be held accountable for any misuse of this product. Each end user assumes all risks associated with the operation of this rocket motor hardware. Sky Ripper Systems will not be held accountable for any injury sustained or damage caused by the operation of this motor hardware. Use of this motor hardware constitutes an agreement of this disclaimer by the end user.



"Scuse me, while I rip the sky"